

TD4CRTTS TOE TOUCH POP-UP BATH DRAIN INSTALLATION

Installation of a bath waste can be the most time consuming operation performed by a plumber. Special attention has been given by Hudson Brass Works™ to simplify this job as much as possible. Observe local plumbing codes.

1. Remove the Toe Touch Pop-Up (M) from the shoe strainer (L). Apply silicone sealant (not included) around the underside flange of the shoe strainer. Align the shoe elbow (J) and the rubber washer (K) under the tub drain hole. Screw the shoe strainer through the tub, into the shoe elbow. Tighten by using pliers or strainer wrench (not included).
2. Position rubber gasket (E) over the lip of the overflow elbow (F).
3. Align the overflow elbow (F) with the overflow hole in the tub. Attach the metal bracket (D) using two machine screws (C). Align the square cover plate (B) with the installed metal bracket (D). Make sure that the hole with the setscrew (A) is facing downward. Snap the square cover plate (B) on to the metal bracket (D) using the hooks on the back. Secure the square cover plate (B) by tightening the setscrew (A).
4. Insert the shorter pipe (I) into the shoe elbow (J). Insert the waste Tee (H) on the other end of the shoe pipe (do not glue yet).
5. Cut the long pipe (G) to the proper length, allow for the insertion depth on either end. Insert the cut pipe into the overflow elbow (F) and the waste Tee (H). Confirm that both pipes will fully seat (do not glue yet).
6. Remove the two pipes (G) and (I). Apply the proper pipe cement for the pipe material, and re-connect the components, following the cement manufacturer's instructions.
7. Connect the waste Tee (H) to the drain pipe in the floor.
8. Thread the Toe Touch Pop-Up (M) into the shoe strainer (L).
9. Test the entire installation by filling the tub with water to the overflow opening. Check for leakage.

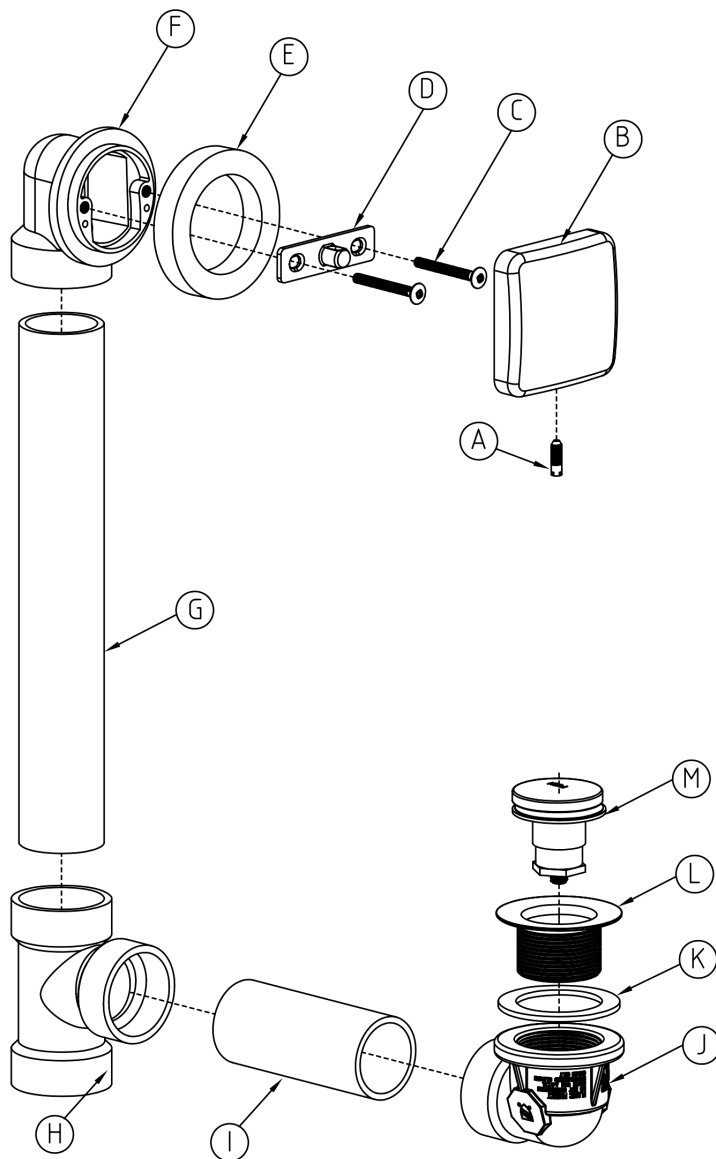

A	Setscrew
B	Square Cover Plate
C	Machine Screw
D	Metal Bracket
E	Rubber Gasket
F	Overflow Elbow
G	Long Pipe
H	Waste Tee
I	Shorter Pipe
J	Shoe Elbow
K	Rubber Washer
L	Shoe Strainer
M	Toe Touch Pop-Up